



BRIDGEPOINT
SYSTEMS

Revised: 01-29-2015



240 Volt Electric Thermal Energy System Operator's Manual



Air Mover not included.

Bridgepoint Systems
4282 South 590 West
Salt Lake City, UT 84123
801-261-1282 | 801-268-3856 fax

“E-TES - World's Fastest Drying System”™

© 2008 Bridgepoint Systems. All Rights Reserved

Table of Contents

Introduction	3
General Information	4

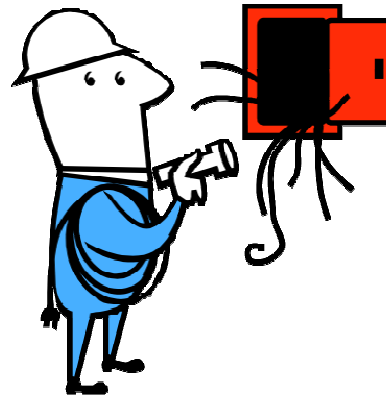

SECTION 1	
Heater Operation Safety	5

SECTION 2	
Drying Carpet	6
Drying Wood Floors	8
Drying Walls	10



SECTION 3	
Heater Operation	12
Troubleshooting	15
Wiring Diagrams	19

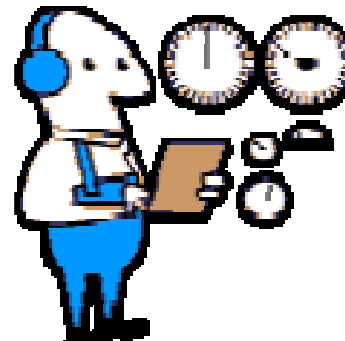

SECTION 4	
Maintenance	22
Parts	23
Warranty	28

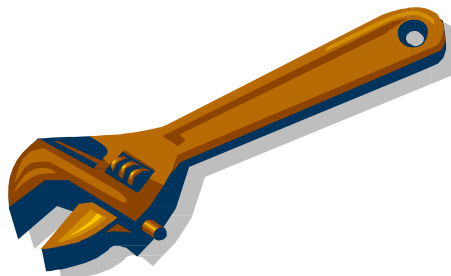

Introduction

Congratulations on your purchase of the Bridgepoint Systems E-TES 240 Volt Electric Thermal Energy System. This manual is a guide for safe operation and maintenance of this unit.

⚠ WARNING Read and understand this manual completely before operating this unit.

The temperature controls of the E-TES 240 Volt Electric Thermal Exchange unit are designed for safe operation in a variety of drying operations. If setup improperly the E-TES SD can raise the room temperature to 200°F with an output temperature up to 240°F before it shuts off. Proper setup and use of the exhaust and temperature control is required to protect the structure and contents.

⚠ DANGER Improper operation, alteration, service or maintenance can cause property damage, personal injury or loss of life. Service must be performed by a qualified technician, service agency or electrician. Bridgepoint Systems is in no way responsible and is excluded from liability in respect to any loss or damage which may arise due to improper operation, maintenance or repair.

This manual should be maintained in legible condition adjacent to the unit or in a secure location for future reference.

Any questions pertaining to the operating or servicing of this unit should be directed to your nearest Bridgepoint Systems distributor.

This manual is written specifically for the E-TES 240 Volt Electric Thermal Exchange units manufactured by:

Bridgepoint Systems

4282 S 590 W

Salt Lake City, UT 84123

801-261-1282

Information in this manual is subject to change without notice and does not represent a commitment on the part of Bridgepoint Systems.

General Information

E-TES 240 ELECTRIC THERMAL ENERGY SYSTEM

21,000 Btu 240vac Electric Model
 Height: 19-7/8"
 Length: 24"
 Width: 20-5/8"
 Weight: 39lbs.
 Heater watt rating: 6200 watts
 Maximum Amp Draw: 25 amps



E-TES 240 Standard Equipment ELECTRIC THERMAL EXCHANGE UNIT

NM4402 50' - 10/3 GFCI Power Cord w/ 10-30P & 6-30R ends
 NM4422 4-Prong 30amp Dryer Plug 14-30P/ 10-30R Adapter Cord



NM4402



NM4422



NM4420

NM4424

Additional / Optional Equipment

NM4420 3-Prong 50amp Range Plug 10-50P/ 10-30R Adapter Cord
 NM4424 4-Prong 30amp Range Plug 14-50P/ 10-30R Adapter Cord
 NM4403 50' - 10/3 Extension Cord w/ 3-Prong 30amp Twist Lock Ends 6-30P & 6-30R
 AC25A Omni Dry 2.9 Centrifugal Air Mover
 MB230 Single Stage Exhaust Controller
 AC514 Flexi-Dry Wall Drying System



NM4403



AC25A



MB230



AC514

WARNING

When using electrical appliances, basic precautions should always be followed to reduce the risk of fire, electric shock, and injury to persons, including the following

- Always use the Ground Fault Circuit Interrupting (GFCI) cords to reduce the risk of electrical shock.
- The 240volt power source must be wired and have circuit breaker sized to safely handle the rated amperage of the unit.
- Connect GFCI power cord to the power source, using adapter as needed. One additional 10/3 x 50 foot extension cord may be placed between GFCI cord and the E-TES unit. No more than two cords (100ft. total cord length) may be used. Use only 10 gauge cords.
- Keep cord connections off wet floors. Protect cord connections from damp surfaces and water sources. Wear rubber boots and rubber gloves when handling heater and cords in damp conditions.
- Never operate this heater with a damaged power cord. If the power cord is damaged it must be replaced.
- Turn E-TES unit heater switch OFF before connecting or disconnecting cord to unit. Unplug machine power cord from outlet before performing any repair on the heater.
- To reduce the risk of property damage or injury, repairs to electrical systems should only be performed by experienced technicians. Contact your nearest service center for assistance.
- Always turn Heater OFF and keep air mover running for 5 minutes to cool heater before turning air mover OFF. If air flow is turned off and the unit is not cooled properly the heater box and front grill may get very hot, creating a burn hazard or damaging the unit.
- Heater snout must be in the horizontal position or directed up. The snout cannot be directed down. Directing the snout down will make the air flow switch inoperable, may result in damage to heater and will void warranty.
- Do not operate this heater unless all panels and guards are in place and properly secured.
- Adequate air flow must be maintained across heating elements for proper, safe operation. Do not disable airflow switch or other safety switches, doing so may result in damage to heater and will void warranty.
- Remove Feet or carpet clamps from snout of air mover before placing air mover into E-TES Electric Thermal Exchanger to prevent damage to air seal gasket.

NOTICE

Always use Exhaust Controllers MB230 or other form of temperature control to keep room temperature below 105°F during the drying process.

Heater Set-up Procedures

The best way to dry wet carpet, hardwood floors and walls is to implement the Reets Evaporation Method utilizing your E-TES unit. The following steps will explain how to this method can be applied for drying different surfaces.

Carpet Drying Procedure

Step #1 - Extraction

1. This is the key for any drying. Extract as much of the water as possible with your portable or truck mounted equipment. A weighted extraction tool will compress the padding and carpet to remove more water. The more you remove with extraction, the faster the carpet will dry. Test extraction by squeezing the pad in your hand. Continue extracting until no more water can be squeezed out. If this level of extraction cannot be achieved, remove the pad.

Step #2 - Energy applied directly to the water (Temperature)

1. To contain the heat and apply the energy (heat) to the carpet and floor.
Set the snout of the E-TES unit under the carpet to create a "soft float".
2. Pull up one corner of the carpet in the wet area and set the E-TES unit in the corner, on top of the pad. Larger rooms may require additional E-TES units. Leave 3-6 inches between the back of the E-TES box and the wall.
3. Pull the carpet up over the snout and secure the carpet to the E-TES unit with the carpet clamp. Then pull the E-TES back toward the wall to pull the carpet tight. Pulling the carpet tight will eliminate or reduce carpet flapping during the float.
4. Now place the one or two 10 lb. sandbags on the carpet, along the wall, on each side of the unit to hold down the carpet and prevent it from pulling off of the tack strip.
5. Cut the pad on each side of the E-TES unit and fold the pad up on top of the carpet. This will help seal the space between the carpet and the floor on each side of the E-TES unit to reduce air escaping. Secure the pad to the carpet with pad pins or use Foam Filler to make a good seal. c\ good seal will increase the amount of heated air flowing under the carpet and improve the float.



SAND BAG



FOAM FILLER

6. Insert a centrifugal air mover into the E-TES box. Plug the air mover cord into the wall outlet. Connect the GFCI power cord to the E-TES and plug the cord into the 240v outlet. Use the appropriate adapter cord if necessary.
7. Turn on the air mover and the E-TES unit.
8. Adjust the speed of the air mover, use additional sand bags to hold the carpet down in some spots and pad pins to lift the carpet in some areas as needed to get the carpet floating and prevent flapping.

PADPIN

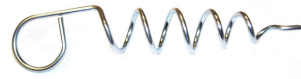

Step #3 - Airflow applied directly to the water (Evaporation)

1. We are getting air movement with the air mover and the E-TES box is providing the heat. We are heating the water to cause the evaporation, and removing the vapor from the floor by providing airflow under and through the carpet. This heated air heats the carpet, walls, baseboards, sill plates and walls up to 12", that may also be wet, creating water vapor. As the air escapes through the carpet and along the walls opposite the E-TES unit, it carries the water vapor away from the wet surfaces.

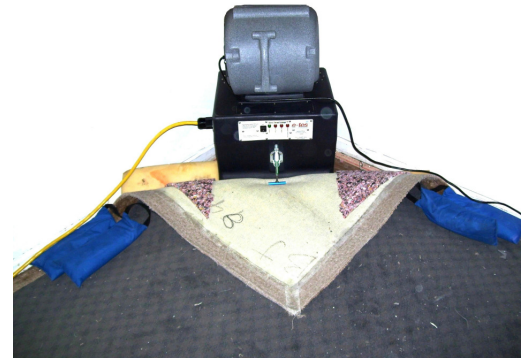

Step #4 - Reduction of vapor saturation levels (humidity) by dehumidification or evacuation (Dehumidification)

1. Now that we have evaporated the moisture into the air, we need to remove it from the structure along with the excess heat. This is accomplished with the exhaust controller, an air mover, 14" lay flat duct and a duct ring. Set up the exhaust system to evacuate to the outside of the structure.
2. Set the MB230 Exhaust Controller to turn on the exhaust fan as needed to keep the ambient room temperature below 105°F.

NOTICE

Overheating the structure may cause damage to structure or contents.

Controlling the room temperature is important to prevent damage.

Monitor your progress at least daily – more often if practical.
Carpet, Floors & Walls will dry quickly.



Air mover with ducting controlled by MB230 Exhaust Controller

Exhaust Controller MB230



Wood Floor Drying Procedure

Step#1 - Extraction

1. This is the key for any drying and especially for wood floor drying. Extract the pooled water on top of the wood with your portable or truck mounted equipment. Use a squeegee type wand. A carpet wand may scratch the floor's finish.
2. You can also use a mop or towels. The more you remove this way, the faster it will dry.
3. Now what about the water between or under the boards? Many times there is still a substantial amount of "free" water that can be extracted to speed up the drying. To remove that water, you need to use a floor drying panel system. Place the panels on the floor and attach the hoses in the position the system will be running; however, before you attach your blower unit, attach it to your extraction unit. Let this run for up to 30 minutes or as long as you can. Pull up each panel and, using a towel, wipe up the excess water that will have been drawn out of the floor system. Depending on the amount of water, you may wish to repeat that step. You will be amazed at the amount of extra water you can remove this way.
4. Now reposition your panels and tape them as needed. Attach your blower and start the system.



Step #2 - Energy applied directly to the water (Temperature)

1. Set up the wood floor drying panels and attach to the vacuum unit that was designed for this application.
2. Direct containment is the best way to apply the energy (heat) to the floor. Spread poly sheeting (4-6 mil.) over the affected floor and cut slightly larger than the area.
3. Now place the 10 lb. sandbags around the perimeter every 3-4 feet or as needed to hold the poly sheeting down. You may even utilize any furniture in the room along the edges to hold the sheeting.
4. Place the snout of the E-TES (Electric Thermal Exchanger) under the sheeting and secure it with the clamp.
5. Insert a centrifugal air mover into the E-TES box. Connect the power cord to the E-TES and plug the E-TES and air mover cords.
6. Turn on the air mover and the E-TES unit.
7. If you have a crawlspace to place an E-TES or can direct more heated airflow below the floor, it will aid in the drying process.
8. It is important that the blower for the floor drying panel system be placed outside the direct containment (i.e. NOT under the poly sheeting).



Step #3 - Airflow applied directly to the water (Evaporation)

1. We are getting air movement with two pieces of equipment - the air mover / E-TES box and also the floor drying panel system. We are heating the water to cause the evaporation, but the floor drying panel system is removing the vapor from the floor by providing airflow through the interspatial cavities in the floor.
2. The sandbags - rather than stapling/taping/sealing - allows the air to escape bringing with it water vapor and heating the walls, baseboards and sill plates that may also be affected.



Air mover with ducting controlled by MB230 Exhaust Controller

Step #4 - Reduction of vapor saturation levels (humidity) by dehumidification or evacuation (Dehumidification)

1. Now that we have evaporated the moisture into the air, we need to remove it from the structure along with the excess heat. This is accomplished with the exhaust controller, an air mover, 14" lay flat duct and a duct ring. Set up the exhaust system to evacuate to the outside of the structure.
2. Set the MB230 Exhaust Controller to turn on the exhaust fan as needed to keep the ambient room temperature below 105°F.

NOTICE

**Overheating the structure may cause damage to structure or contents.
Controlling the room temperature is important to prevent damage.**

Since there is less water in the wood than would be in a carpet/pad combination, the exhaust doesn't need to cycle as often. Monitor your progress at least daily – more often if practical.
Floors will dry quickly!

Exhaust Controller MB230



Wall Drying Procedure

Step #1 – Access Wall Cavity

1. Remove the base board from the wall. Remove the base board carefully, including cutting any caulk bead at the top to prevent damage to the drywall. If not damaged, the base board can be re-installed after the drying process is completed.
2. Locate the wall studs in the area to be dried.
3. Drill 1" diameter access holes through the wall. Locate the holes between the studs, just above the wall base plate. Whenever possible place holes where they will be covered by the base board after drying is completed.
4. Insert one Flexi-Dry outlet tube into each hole. Turn tube to point air flow in the desired direction. Multiple Flexi-Dry units can be connected together for larger areas.

Step #2 - Energy applied directly to the water (Temperature)

1. Insert the snout of the E-TES unit into the large opening of the Flexi-Dry. Secure the Flexi-Dry to the E-TES snout with the Velcro strap and the carpet clamp. Seal the ends of the Flexi-Dry to prevent air leaking. When using multiple Flexi-Dry units connected together, seal the Velcro strips on the other large openings to prevent air from leaking out.
2. Insert a centrifugal air mover into the E-TES box. Plug the air mover cord into a wall outlet. Connect the power cord to the E-TES and plug the E-TES GFCI cord into a 240v outlet. Use the appropriate adapter cord if necessary.
3. Turn on the air mover and the E-TES unit.
4. In some cases the Flexi-Dry may restrict the E-TES outlet air flow enough to prevent the E-TES airflow switch from engaging. The Airflow Light will remain off and the heater will not get hot. If the air mover is running and the Airflow Light is off, open one end of the Flexi-Dry to increase the total airflow. Open the end a small amount at a time until Airflow light comes on. Only open the end as much as needed to engage the airflow switch. Opening the end too much may reduce the flow through the outlet tubes and increase the drying time.



FLEXI Dry Secured to E-TES SD Snout



End opened for increased airflow

Step #3 - Airflow applied directly to the water (Evaporation)

1. We are getting air movement into the wall with the air mover / E-TES box and the Octi-Dry system. We are heating the water to cause the evaporation, but the water vapor still needs to be removed from the wall.
2. If the wall is wet top to bottom, air outlet holes may need to be drilled at the top of the wall between the studs to allow the water vapor to be removed from the wall cavity. If the wall is only wet at the bottom, drill an outlet hole below the baseboard level to allow moist air to escape.

Step #4 - Reduction of vapor saturation levels (*humidity*) by dehumidification or evacuation (*Dehumidification*)

1. Now that we have evaporated the moisture into the air, we need to remove it from the structure along with the excess heat. This is accomplished with the exhaust controller, an air mover, 14" lay flat duct and a duct ring. Set up the exhaust system to evacuate to the outside of the structure.
2. Set the MB230 Exhaust Controller to turn on the exhaust fan as needed to keep the ambient room temperature below 105°F.

NOTICE

Overheating the structure may cause damage to structure or contents.

Controlling the room temperature is important to prevent damage.

Monitor your progress at least daily – more often if practical. Walls will dry quickly.



Air mover with ducting controlled by MB230 Exhaust Controller



**Exhaust Controller
MB230**

Heater Operation Procedure

WARNING

Knowledge of the proper operation of the heater and heat exchange system is required for safe operation and to keep heater and components operating properly.

- 1) Place the E-TES unit as required for your drying situation. (SEE SET-UP SECTION #2)
- 2) Place an air mover into the E-TES unit. Plug in the air mover and turn the air mover switch ON.
- 3) Connect GFCI cord to 30 amp 240 vac outlet. Use appropriate adapter for cord to connect to outlet. Use a 50 foot extension cord if needed.
- 4) Make sure E-TES unit heater switch is in the OFF position, and then connect the plug end of GFCI cord or extension cord to E-TES unit.
- 5) Reset GFCI. Push TEST button to test GFCI and if RESET button pops out, push RESET button back in and proceed with set-up. If RESET button does not pop out when TEST button is pushed, replace cord or contact your nearest service center for advice or assistance.
- 6) Turn TEX unit heater switch to the ON position. Observe indicator lights. When all four lights are illuminated system is operating properly and the heating elements are getting power.
 - **POWER** - when the green light is lighted it indicates that the heater switch is in the ON position and the 240 vac power has been supplied to the heater. (If the green light is off the red lights will not light.)
 - **AIR FLOW** - when the first red light is lighted it indicates that there is sufficient air flow for the heater to operate. (If one of the other red lights turns off, the AIR FLOW light will also turn off. If the AIR-FLOW light turns off the other lights may still be lighted.)
 - **HI TEMP** - when the second red light is lighted it indicates that the heating element temperature is in the safe operating range and power is still being supplied to the heating elements. (If the HI TEMP light turns off, the AIR FLOW light will also turn off, but the SAFETY SHUTDOWN light may remain lighted.)
 - **SAFETY SHUTDOWN** - when the last red light is lighted it indicates that the box around the heating elements is at a safe temperature and power is still being supplied to the heating elements. (If the SAFETY SHUTDOWN light turns off the other red lights will also turn off. If the AIR FLOW light and/or HI TEMP lights are off the SAFETY SHUTDOWN light may remain lighted.)

- If the lights are not all lighted look for the following: See the troubleshooting section for more information on the meaning different light configurations.
 - If the other three lights are on, but the AIR FLOW light does not come on, make sure you have power to the air mover and it is ON and running. If you are using a Flexi-Dry or the air flow coming out of the TEX unit is restricted in other ways, the reduced air flow may not allow the air flow switch to be engaged. Open one end of the Flexi-Dry or remove restriction. Open it only as much as needed to engage the air flow switch. If the AIR FLOW light does not come on contact your nearest service center for advice or assistance.
 - If only the last red light, the SAFETY SHUTDOWN light is ON but the other lights are off, the heating elements may have reached the maximum temperature and the power to the heating elements has been cut-off to allow them to cool. Turn the heater switch off. Make sure the air mover is ON and remove any restriction to allow the air flow to cool the elements. when cool turn the heater switch back ON.
 - If the last red light, the SAFETY SHUTDOWN light is OFF and both of the other red lights are also OFF, the box around the heating elements may have reached a temperature high enough to trip the SAFETY SHUTDOWN Switch.
 - a) On units manufactured after December 2007, the SAFETY SHUTDOWN switch is an automatic reset switch. Turn the heater switch off. Make sure the air mover is ON and remove any restriction to allow the air flow to cool the elements. When the unit has cooled, repeat the set-up instructions and resume heating. If the SAFETY SHUTDOWN switch has not been tripped or does not reset, contact your nearest service center for advice or assistance.
 - b) On units manufactured before December 2007, the SAFETY SHUTDOWN switch must be manually re-set before the unit can return to service. Un-plug the TEX Thermal Exchange unit and allow the unit to cool. When cool, remove the access panel on the top front of the unit. Reach down inside the box to push in the center button of the switch. You will feel or hear a click when the switch is reset. Examine the unit to determine if there has been any damage to the unit or if there is a problem with the wiring. If damaged, do not return the unit to service until it has been repaired. When you are sure the unit has not been damaged, replace the access panel and secure the panel in place with the six screws. Repeat the set-up instructions and resume heating. If the SAFETY SHUTDOWN switch has not been tripped or cannot be reset, contact your nearest service center for advice or assistance.
 - If the last red light, the SAFETY SHUTDOWN light is OFF and one or both of the other red lights are ON, the SAFETY SHUTDOWN light is burned out or there is a problem with the wiring. Replace the SAFETY SHUTDOWN light or contact your nearest service center for advice or assistance.
- 7) Observe unit operation to be sure that air flow is kept at a high enough flow rate to prevent the heater from turning ON and OFF. Remove restrictions to increase air flow as needed to maintain proper air flow rate.
- 8) Make sure circuit breakers are not tripping and the power supply to the air mover and E-TES unit will not be interrupted.
- 9) When the E-TES unit is adjusted properly and operating normally, the unit can be left alone during operation.

HEATER SHUTDOWN PROCEDURE

- 1) Turn the heater switch to the OFF position.
- 2) Keep the air mover running for 5 minutes to cool the heating elements.
- 3) When the unit has cooled turn the air mover OFF.
- 4) Disconnect the power cord from the power outlet and heater connection. Roll up and store cord.
- 5) Remove and store air movers and E-TES Electric Thermal Exchanger.

Heater Troubleshooting

Problem	Cause	Solution
240vCircuit Breaker	Circuit Breaker rated too low for power demand of heater	The E-TES unit requires a 30 amp circuit breaker. Move plug to another outlet & circuit or have electrician replace circuit breaker
Blowing	Too much current demand on circuit	Move plug to another outlet & circuit or disconnect other devices from this circuit.
	Circuit breaker faulty	Move plug to another outlet & circuit or have electrician replace circuit breaker
	Heating Element faulty	Replace Heating Element
	Faulty power cord	Replace cord
	Faulty switches or internal wiring	Check wiring & test switches - Repair as needed *
Unit Not Heating	Heater Switch in OFF position	Turn switch to ON position
	240v Building circuit breaker tripped.	Reset breakers or move cord to another outlet
	GFCI tripped	Reset GFCI
	Faulty power cord	Replace cord
	Faulty GFCI	Replace cord
	Air Mover not running	Turn on air mover or check power to air mover. Repair or replace air mover as needed
	Low Air Flow	Remove restrictions to maintain adequate air flow
	Faulty switches or internal wiring	Check wiring & test switches - Repair as needed *
	Faulty Safety Switch	Observe Lights to determine function Correct condition or Repair as needed *
Heater Power Light Not Lighted (GREEN)	Heater Switch in OFF position	Turn switch to ON position
	240v Building circuit breaker tripped.	Reset breakers or move cord to another outlets
	GFCI tripped	Reset GFCI
	Faulty power cord	Replace cord
	Faulty GFCI	Replace cord
	Faulty switches or internal wiring	Check wiring & test switches - Repair as needed *
	Faulty indicator light	Replace light

* **⚠ WARNING** To reduce the risk of injury, repairs to electrical systems should only be performed by experienced technicians. Contact your nearest service center for assistance.

Heater Troubleshooting

Continued

Problem	Cause	Solution
Air Flow Light Not Lighted (RED)	Air Mover not running	Turn on air mover or check power to air mover. Repair or replace air mover as needed
	Low Air Flow	Remove restrictions to maintain adequate air flow
	No Power	Check green power light – See previous section
	Unit Overheated	Let unit cool. Reset Hi-Limit Switch as needed.
	Faulty switches or internal wiring	Check wiring & test switches - Repair as needed *
	Faulty indicator light	Replace light
	Faulty Safety Switch	Observe Lights to determine function Correct condition or Repair as needed *
Heater Hi Temp Light Not Lighted (RED)	Unit Overheated	Let unit cool. Reset Safety Shutdown Switch as needed.
	No Power	Check green power light – See green light section
	Faulty switches or internal wiring	Check wiring & test switches - Repair as needed *
	Faulty indicator light	Replace light
	Faulty Safety Switch	Observe Lights to determine function Correct condition or Repair as needed *
Heater Safety Shutdown Light Not Lighted (RED)	Unit Overheated	Let unit cool or Reset manual reset Safety Shutdown Switch as needed.
	No Power	Check green power light – See green light section
	Faulty switches or internal wiring	Check wiring & test switches - Repair as needed *
	Faulty indicator light	Replace light
	Faulty Safety Switch	Observe Lights to determine function Correct condition or Repair as needed *
System Overheating	Faulty switches or internal wiring	Check wiring & test switches - Repair as needed *
	Faulty Safety Switch	Observe Lights to determine function Correct condition or Repair as needed *
	Not enough Heat draw from system Air Flow too low	Turn air movers switches to higher speed or remove Restrictions to Increase air flow
	Room Temperature too high	Use exhaust controllers to reduce room temperature

* **⚠️ WARNING** To reduce the risk of injury, repairs to electrical systems should only be performed by experienced technicians. Contact your nearest service center for assistance.

E-TES 240 INDICATOR LIGHT PANEL CONFIGURATIONS

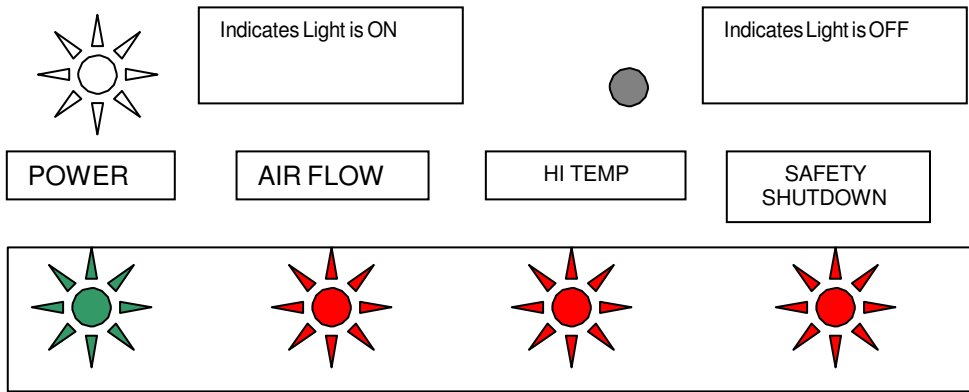

When all the lights are ON as shown above, the heater is operating normally and the heating elements are receiving power.

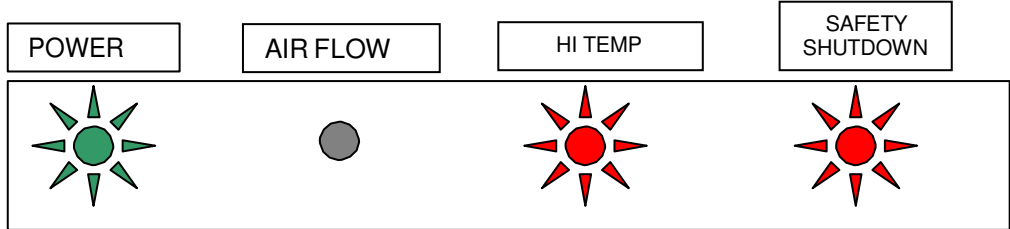

When the POWER, HI TEMP and SAFETY SHUTDOWN lights are all ON and the AIR FLOW light is OFF, it means the AIR FLOW is too low to engage the AIR FLOW switch. The power to the heating elements is cut-off. Turn the air mover ON, turn the air mover to a higher speed setting or remove air flow outlet restrictions as needed to achieve and maintain adequate air flow.

If the light does not come back on when adequate air flow has been restored, the AIR FLOW switch, light or wiring may be damaged. Contact your nearest service center for advice or assistance.

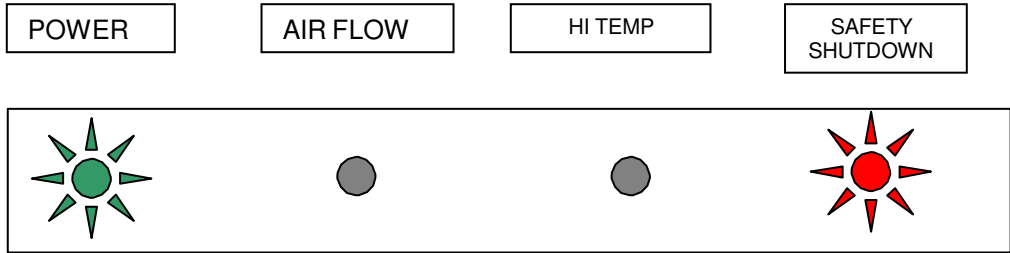

When the POWER and SAFETY SHUTDOWN lights are ON and the AIR FLOW and HI TEMP lights are OFF it is an indication that the temperature of the heating elements has exceeded the safe temperature and the power to the heating elements has been turned off. Make sure the air mover is still ON to cool the heating elements. The HI TEMP switches will also turn off the AIR FLOW light even if there is adequate air flow. Once the unit has cooled, the lights should come back on and normal operation will resume. The SAFETY SHUTDOWN light will remain ON as long as the heater box is still at a safe temperature.

If the lights do not come back on when the unit has cooled, the HI TEMP switches, lights or wiring may be damaged. Contact your nearest service center for advice or assistance.

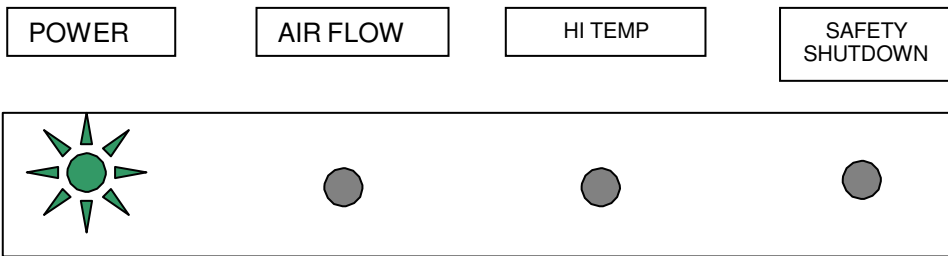

When the POWER light is ON and the AIR FLOW, HI TEMP and SAFETY SHUTDOWN lights are OFF it is an indication that the temperature of the box enclosing the heating elements has exceeded the safe temperature and the power to the heating elements has been turned off. Make sure the air mover is still ON to cool the heating elements. The SAFETY SHUTDOWN switch will also turn off the HI TEMP light and AIR FLOW light even if there is adequate air flow. The POWER light will remain ON as long as the unit is plugged in and the heater switch is in the ON position. Once the unit has cooled, on units with an auto reset SAFETY SHUTDOWN switch, the lights will come back on and the unit will return to normal operation. On older units with a manual reset SAFETY SHUTDOWN switch, the switch will need to be reset before heating will resume.

If the lights do not come back on when the unit has cooled (and if so equipped the manual reset switch has been reset) the SAFETY SHUTDOWN switch, lights or wiring may be damaged. Contact your nearest service center for advice or assistance.

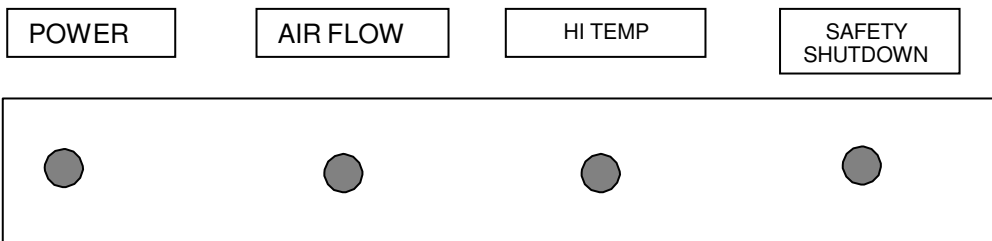

The power supply to the TEX unit has been cut off. Check the building 240v circuit breaker and the GFCI and reset as needed. There also could be a malfunction in the heater switch or other internal wiring. Contact your nearest service center for assistance.

ALL OTHER LIGHT COMBINATIONS WILL ONLY OCCUR WHEN THERE IS A MALFUNCTION IN THE SYSTEM. IF YOU HAVE A LIGHT COMBINATION NOT SHOWN AND DESCRIBED HERE, CONTACT YOUR NEAREST SERVICE CENTER FOR ADVICE OR ASSISTANCE.

Heater Wiring

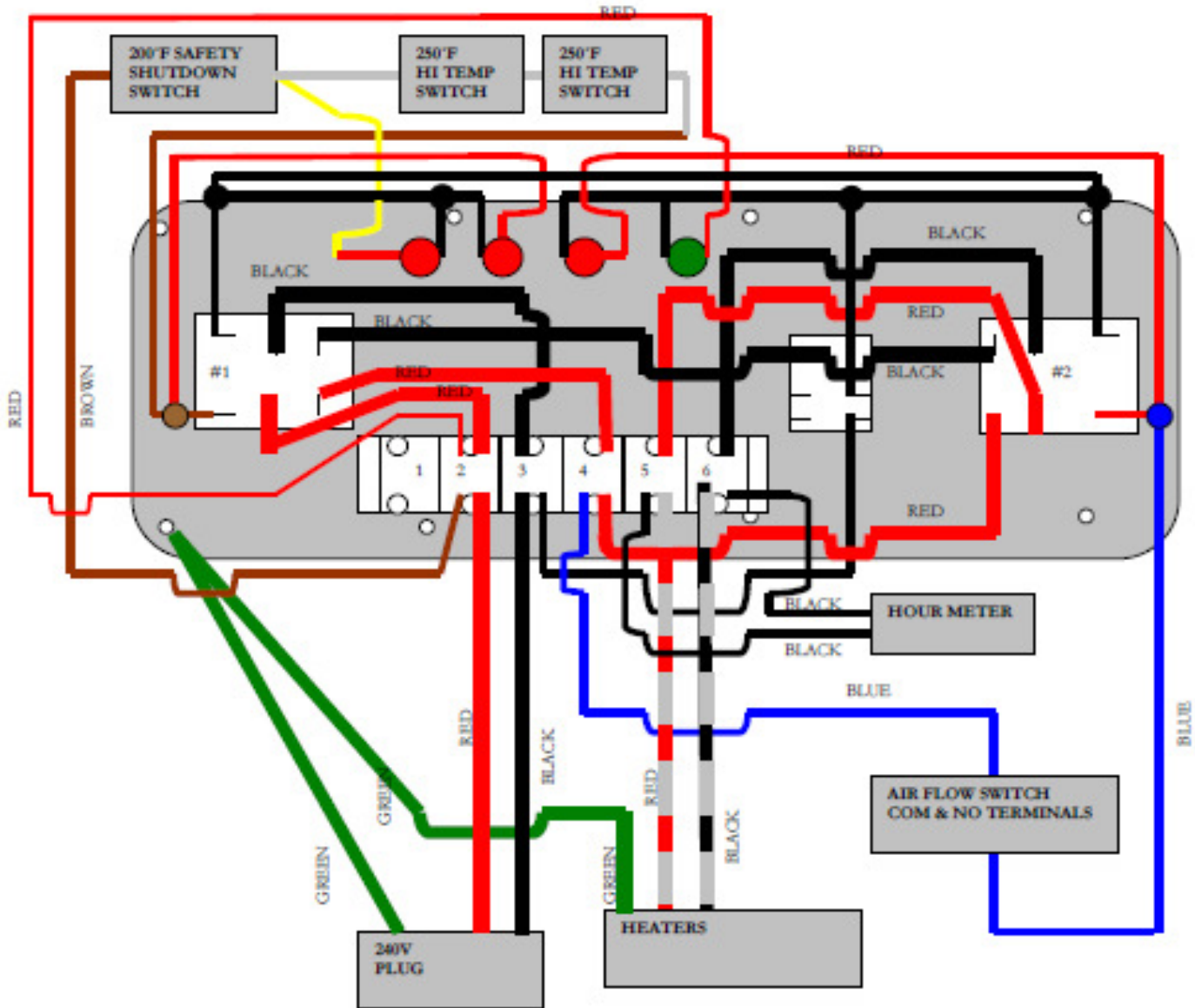

RELAY #1



Relay #1 coil - 240vac
 Relay #2 coil - 240vac
 (Coil Terminals are #1 & #0)

Both relays are: DPST - NO

RELAY #2

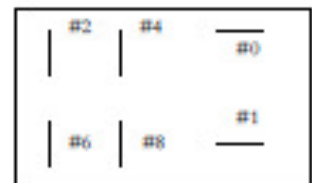

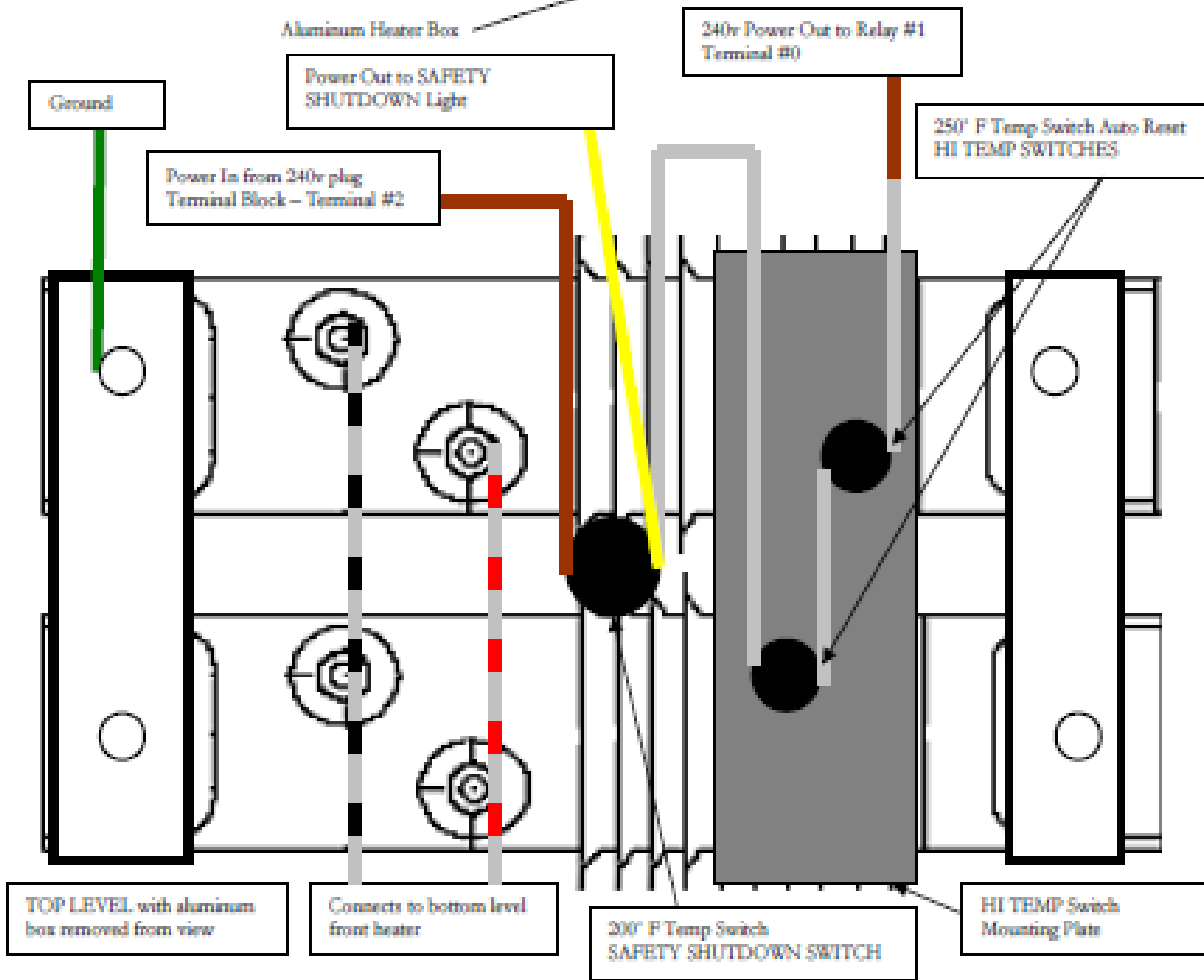
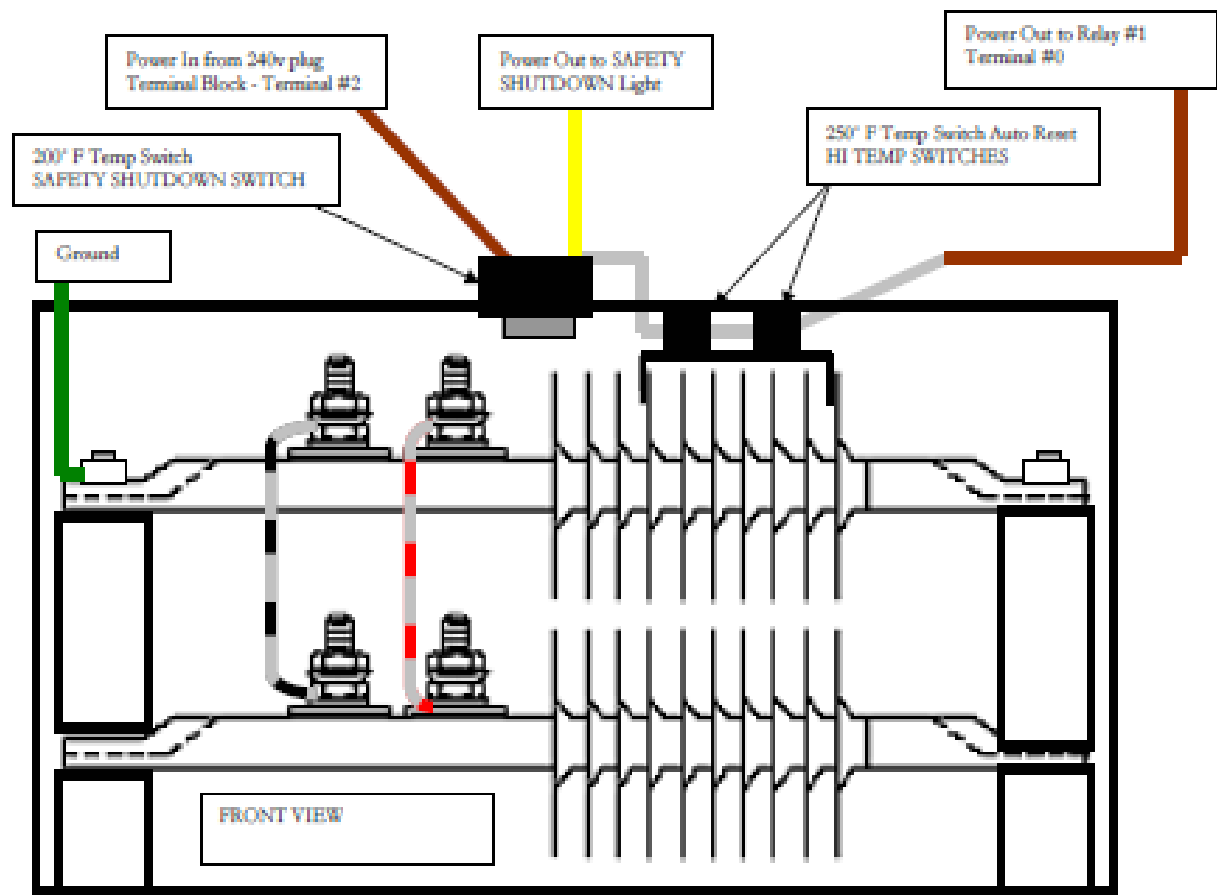

240v Power in from Relay #2
Terminal Block - Terminals #5 & #6

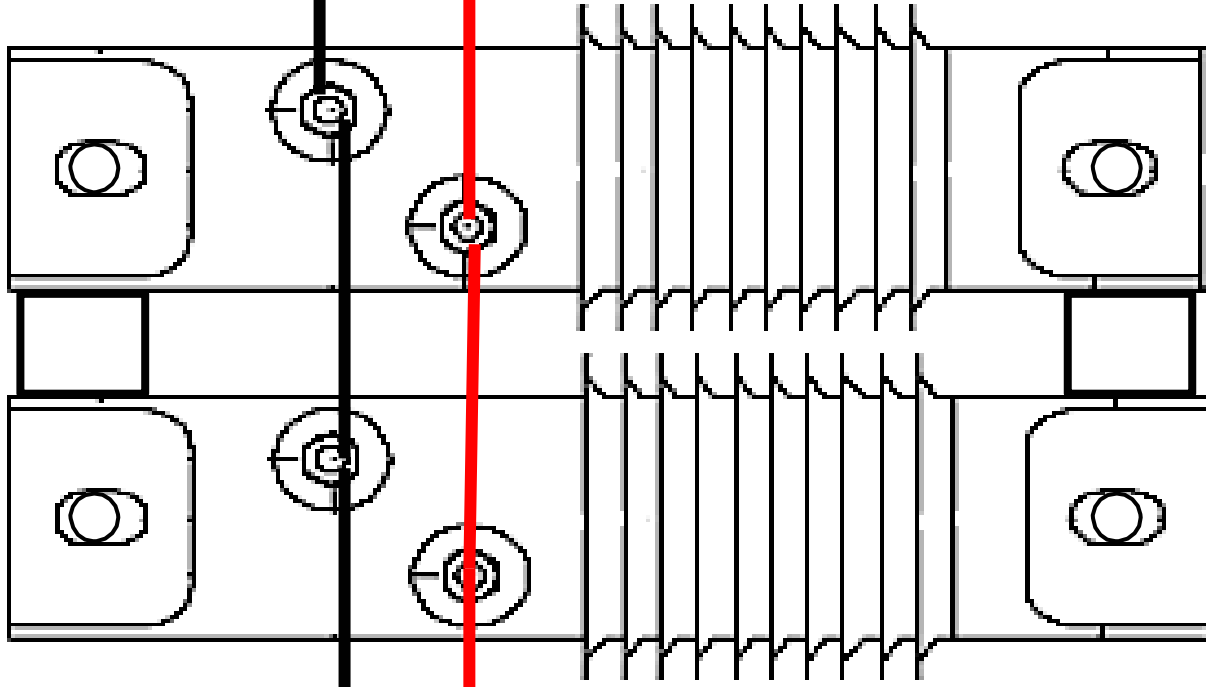

CONNECT TO TOP LEVEL
FRONT HEATER

BOTTOM LEVEL with top level and
aluminum box removed from view

Heater Maintenance

The E-TES 240 Volt Electric Thermal Exchanger requires very little maintenance.

⚠️ WARNING

To keep this unit in safe operating condition, perform the following inspections each time before using this equipment:

- Remove lint or debris that may be collecting on heating elements or inside E-TES unit.
- Examine wiring to ensure wiring to switches and heating elements is not damaged or worn. Check wire connections to ensure that they are tight and have not worked loose due to vibration or other related conditions. Repair or replace wires before using this equipment.
- Examine plastic E-TES 240 Volt unit body for damage and repair or replace as needed.
- Check power cords for wear or damage and repair or replace as needed.
- Test GFCI and replace cord if GFCI is not operating properly. Replace cord as needed.

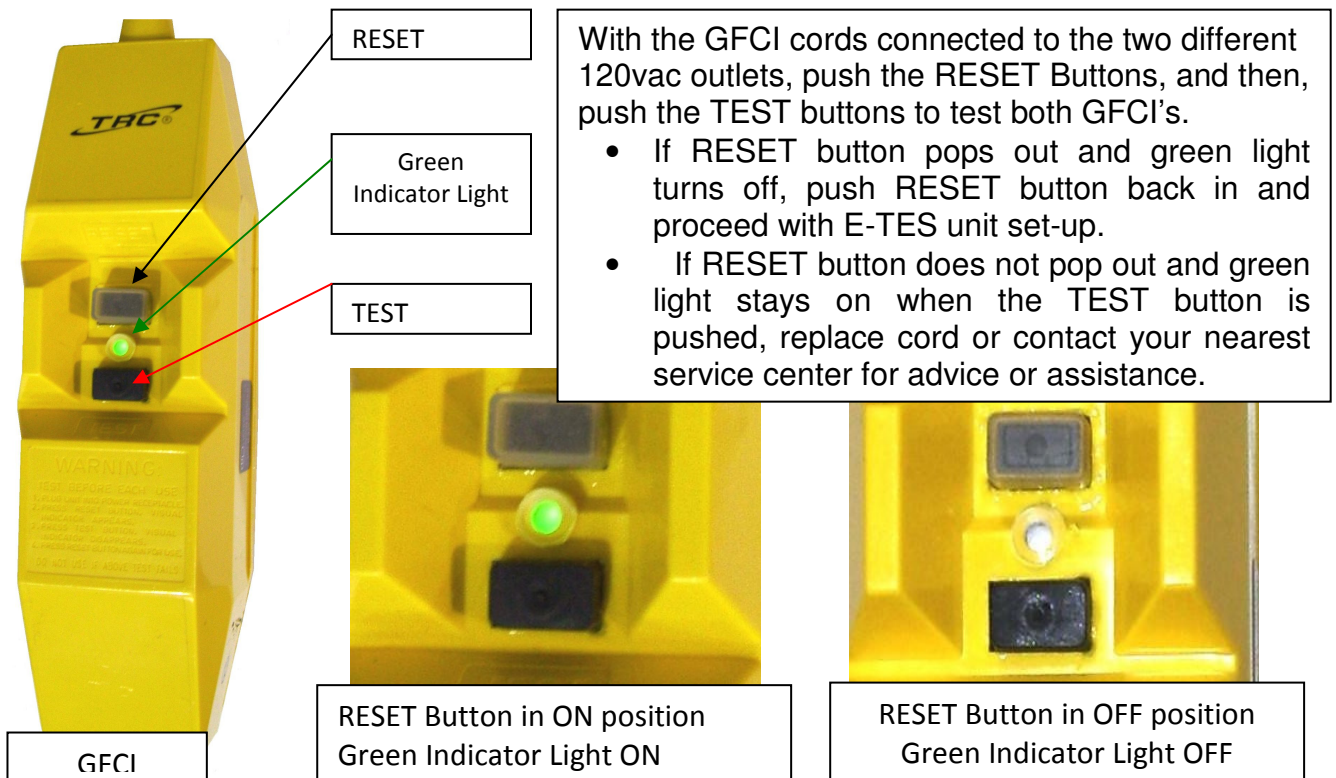

Parts

Parts for repairing your E-TES 240 ELECTRIC THERMAL EXCHANGER.



FRONT SWITCH PLATE AND 240VAC PLUG

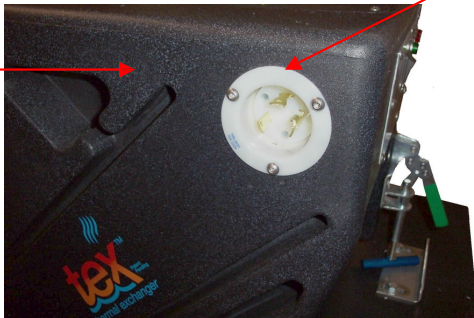

1	FRONT SWITCH PLATE w/ DECAL	NM4412	7	BODY TEX THERMAL EXCHANGER - PLASTIC	NM4250
2	ROCKER SWITCH	NM5008	8	HOUR METER - ROUND NEWER STYLE	NM4300c\
3	GREEN LIGHT 240V	NM4446	8	HOUR METER - RECTANGULAR OLDER STYLE	NM4300
4	RED LIGHT 240V	NM4448			
5	SCREW 10-32 X 7/8" BHCS SS (QTY 14)	NM4240	NS	FLATWASHER #10 SS	NM4255
5c\	NUT 10-32 NYLOCK SS (QTY 14)	NM4081	NS	RELAY 240Vc\c COIL DPST (QTY 2)	NM4450
6	PLUG 30c\MP FLANGED 3-PRONG L6-30P	NM4400	NS	TERMINAL BLOCK DOUBLE ROW SIX POSITION - 30c\MP	NM4452

ELECTRIC TEX BODY AND EXTERIOR COMPONENTS

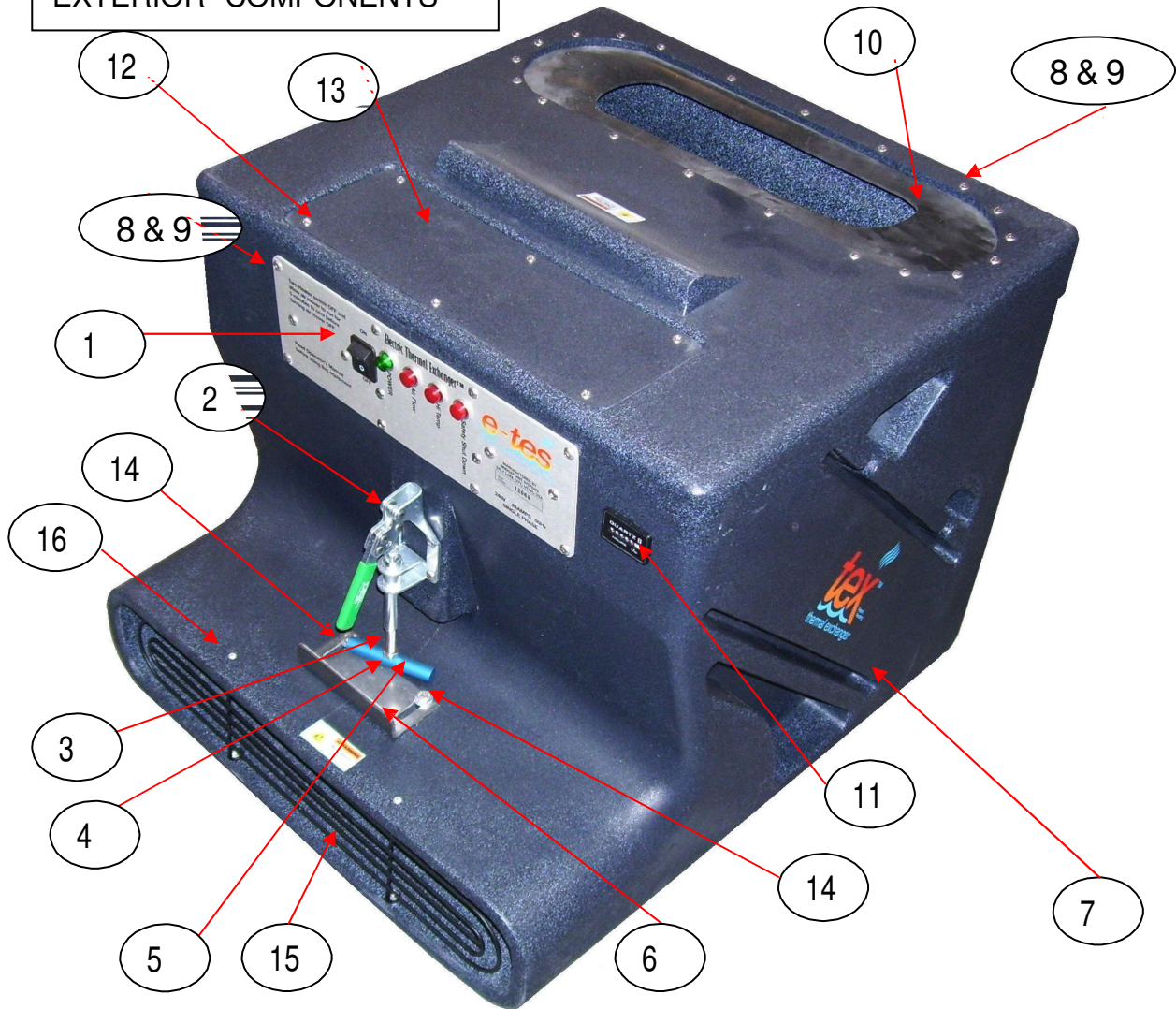

1	FRONT SWITCH PLATE w/DECAL	NM4412	11	HOUR METER - RECTANGULAR OLDER STYLE	NM4300
2	CLAMP TOGGLE	NM4245	12	SCREW 10-32 X 3/8" PH SS	
3	STUD 5/16-18 X 2"	NM4246	13	COVERPLATE - TEX	
4	NUT 5/16-18 HEX	NM4290	14	SCREW 1/4-20 X 1" HX HD	NM5034
5	BAR Cc\RPET CLAMP /2" X 3"	NM4247	15	FRONT GRILLE	NM4430
6	PLATE Cc\RPET CLAMP		16	RIVET 1/8" X 3/4" c\LUMINUM	NM5025
7	BODY TEX THERMAL EXCHANGER (Includes #6, #12, #13 & Snout Support Bracket)	NM4250	NS	NUT 1/4-20 HEX NYLOCK	NM4261
8	SCREW 10-32 X 7/8" BHCS SS	NM4240	NS	BRACKET SNOOT SUPPORT TEX	
9	NUT 10-32 NYLOCK SS	NM4081	NS	INSIDE GRILLE	NM4432
10	GASKET SILICONE RUBBER	NM4238	NS	PLUG 30cMP FLANGED 3-PRONG	NM4400
11	HOUR METER - ROUND NEWER STYLE	NM4300c\	NS	RETAINER PLATE - GASKET	NM4241

CARPET CLAMP ASSEMBLY

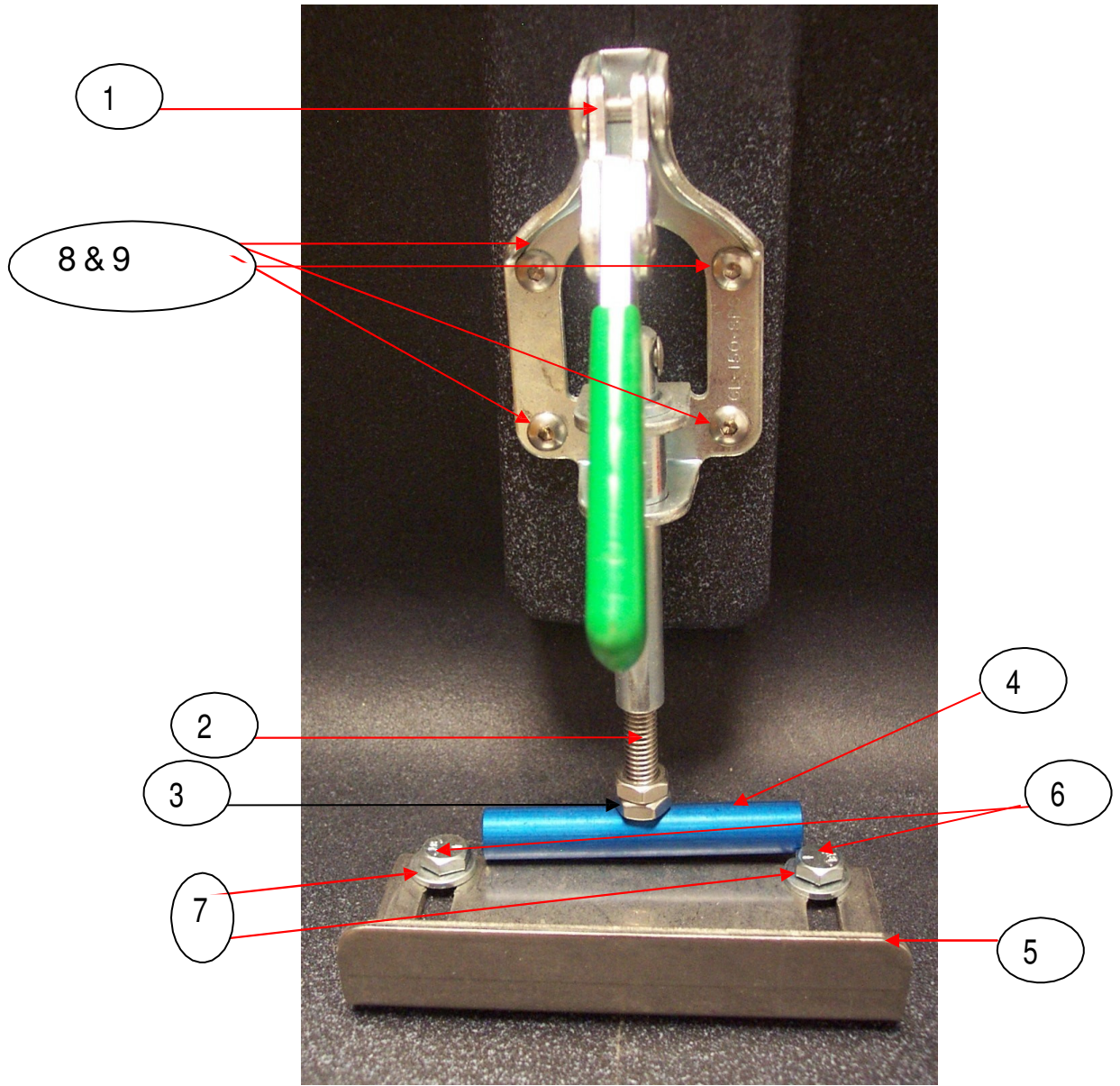

1	CLAMP TOGGLE	NM4245	7	FLATWASHER 1/4"	
2	STUD 5/16-18 X 2"	NM4246	8	SCREW 10-32 X 7/8" BHCS SS	NM4240
3	NUT 5/16-18 HEX (Qty 2)	NM4290	9	NUT 10-32 NYLOCK SS	NM4081
4	BAR CARPET CLAMP 1/2" X 3"	NM4247	NS	BRACKET SNOOT SUPPORT TEX	
5	PLATE CARPET CLAMP		NS	NUT 1/4-20 HEX NYLOCK SS	NM4261
6	SCREW 1/4-20 X 1" HXHD SS	NM5034	NS	SCREW 1/4-20 x 1/2" PHFTHDSS	

HEATER BOX ASSEMBLY
FRONT VIEW

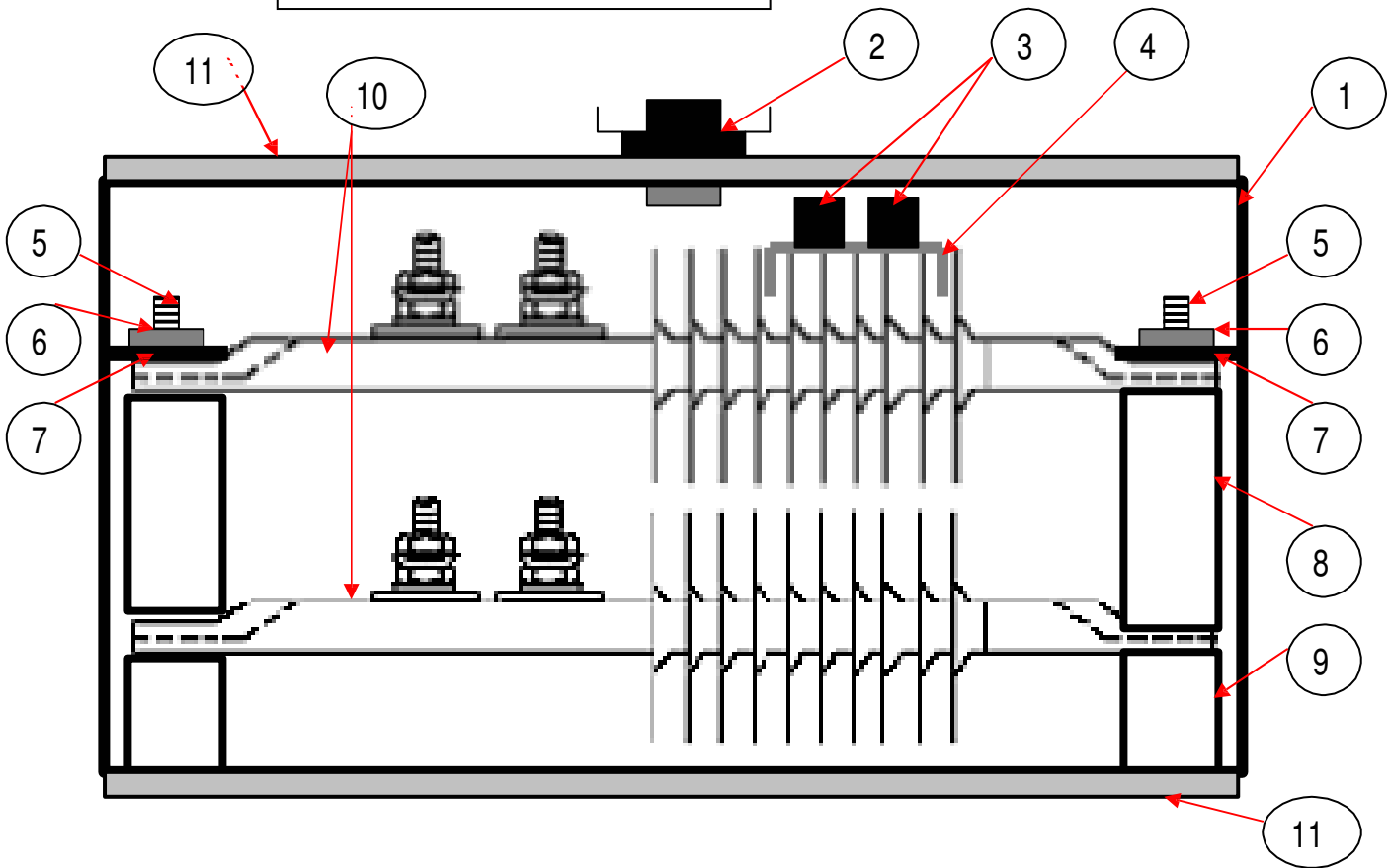

1	HEATERBOX - ALUMINUM	NM4414	10	HEATING ELEMENT 17-7/8" 240VAC - 1550 WATT (QTY 4)	NM4444
2	SWITCH 200°F SAFETY SHUTDOWN	NM4404	11	INSULATION 1/4" X 18" X 6" (QTY 2)	NM4440
3	SWITCH 250°F AUTO RESET HI TEMP (QTY 2)	NM4408	NS	SIDE FLAPS - SET OF TWO	NM4416
4	BRACKET TEMPSWITCHMOUNT	NM4418	NS	TRIMLOCK X2013 SIDE FLAP EDGE PROTECTION (Sold per inch - QTY 8")	NM4273
5	SCREW 5/16-18 X 3-1/2" PFLTHD SS (QTY 4)	NM4256	NS	BRACKET cIR FLOW SWITCH	NM4410
6	NUT 5/16-18 HEX NYLOCK SS (QTY 4)	NM4258	NS	AIR FLOW SWITCH	NM4406
7	FLAT WASHER 5/16" SS (QTY 4)	NM4251	NS	PADDLE AIR FLOW SWITCH	NM4434
8	NYLON BLOCK 1-1/2" (QTY 2)	NM4442	NS	RIVET 1/8" X 1/8" cLUMINUM (QTY 2)	NS116
9	NYLON BLOCK 3/4" (QTY 2)	NM4443			

AIR FLOW SWITCH
ASSEMBLY

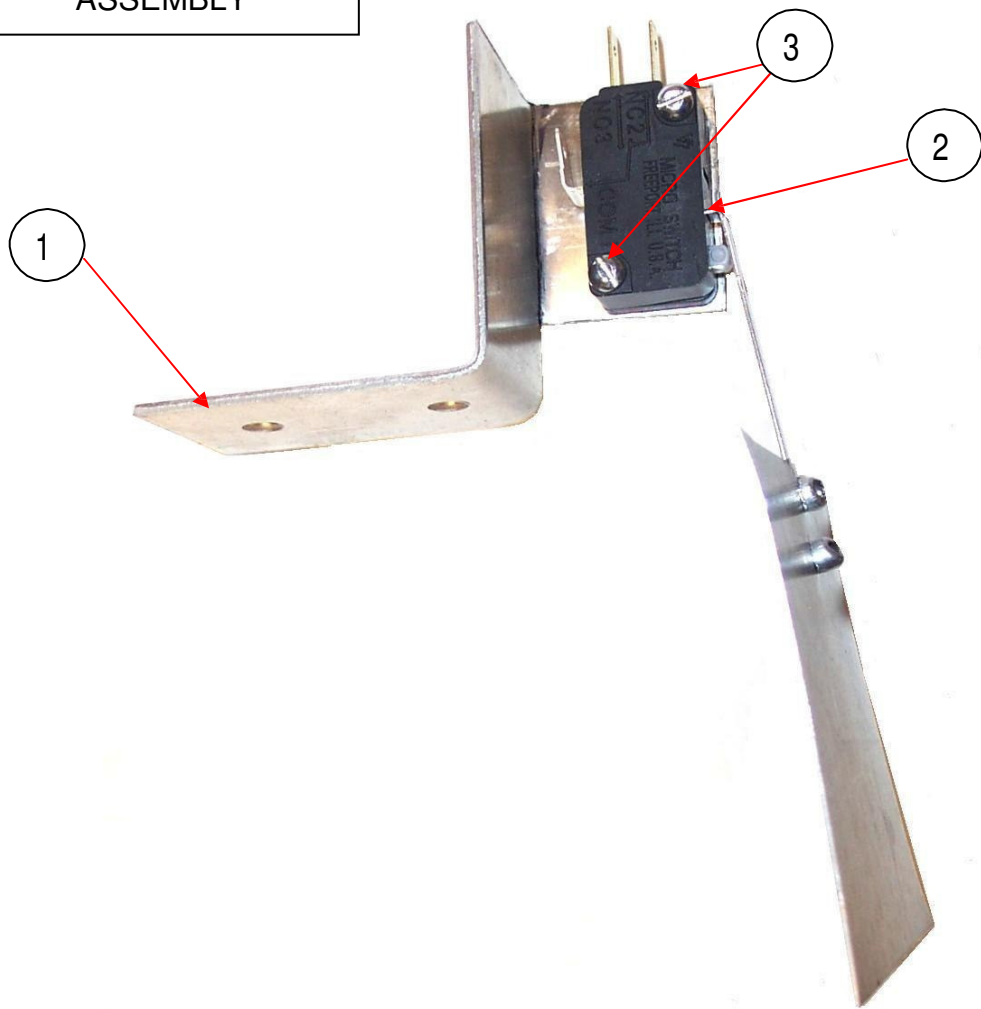

1	BRACKET AIRFLOW SWITCH	NM4410	NS	NUT 4-40HEX (QTY 2)	NM4240
2	AIR FLOW SWITCH WITH PADDLE	NM4435	NS	SCREW #8 X 1/2" PHPNHD SS SELF TAP (QTY 2)	NM4081
3	SCREW #4-40 X 3/4" PHPNHD (QTY 2)	NM4041			

Warranty

Your E-TES 240 Electric Thermal Exchanger is designed to give you years of reliable service. If a problem should arise use the troubleshooting section in the operation manual to diagnose and correct the problem if possible. If you are unable to determine the cause or solution to the problem contact your distributor or Bridgepoint Systems for assistance.

Bridgepoint Systems warrants the roto-molded body of the E-TES 240 Electric Thermal Exchanger to be free from defects in material or workmanship for five years from the date of purchase.

Warranty coverage does not include damage to body due to overheating after the first year.

All other components of the E-TES 240 Electric Thermal Exchanger are warranted to be free of defects in material and workmanship for one year from the date of purchase.

During the warranty period, Bridgepoint Systems will, at its option repair or replace components which prove to be defective.

- This warranty does not provide for replacement of complete units due to defective components.
- Service Labor is only covered for the first 90 days after the date of purchase.
- Any costs for transportation are not covered in this warranty.
- Replacement parts are warranted only for the remainder of the original warranty period.

This warranty shall not apply to defects resulting from improper operation, lack of maintenance, condensation, chemical corrosion, unauthorized modification, misuse or abuse.

This warranty does not cover normal wear to items such power cords, plug adapters or other items which require replacement as a result of ordinary usage.

To obtain warranty service for the E-TES 240 Electric Thermal Exchanger, contact your distributor or Bridgepoint Systems. If the unit must be returned to Bridgepoint Systems or an authorized service center, the purchaser shall prepay shipping charges for products returned for warranty service.

- No returned items will be accepted by Bridgepoint Systems without prior authorization. All returns must have a return authorization number, issued by Bridgepoint Systems, clearly marked on the exterior of the package.

Bridgepoint Systems makes no other warranty either expressed or implied with respect to this product. The remedies provided herein are the purchaser's sole and exclusive remedies.

In no event shall Bridgepoint Systems be liable for any direct, indirect, special, incidental or consequential damages.

This warranty gives you specific legal rights. You may also have other rights which vary from jurisdiction to jurisdiction.